

The AQUAvalve5 is the patented, power-free water control device that regulates the supply of water and fertiliser to your Tray2Grow. These Simple Care Guidelines will help ensure your AQUAvalve5 functions perfectly and produces excellent results every time - for years to come.

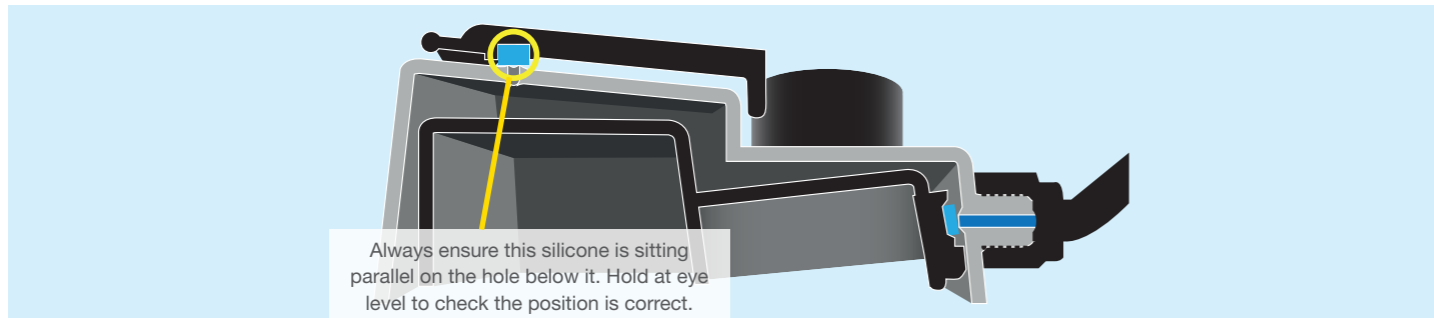

Always ensure this silicone is sitting parallel on the hole below it. Hold at eye level to check the position is correct.

Ensuring that the AQUAvalve5 floods and drains correctly

- 1** Making sure your AQUAvalve5 floods and drains correctly is simply achieved and only takes a few seconds.
- 2** Hold the AQUAvalve5 at eye level so that you can see the silicone fitted to the top float resting on the hole below it.
- 3** The silicone must create a tight seal when touching the hole.
- 4** If it looks like it is not sitting parallel on the hole below, simply lift the top float and apply pressure to one side of the silicone, drop the float and hold at eye level again. Repeat the procedure if necessary.

Care and maintenance

- 1** At the end of your growing season, clean the AQUAvalve5 using warm soapy water. Using an old tooth brush will help. The AQUAvalve5 is easily disassembled. The top float will slide all the way across and the bottom float is unclipped from its pivoting position. The circular discs fitted to the top float can also be removed by using pliers to grip the raised point. At this point it is advisable to remove the silicones to avoid them being lost.
 - 2** It is also handy to have a paper clip or pipe cleaner to hand so that you can push it through the AQUAvalve5 nozzle, this will remove any limescale build-up that may have occurred during the growing season. Blowing through the AQUAvalve5 nozzle will also help to remove any build up.
- Do not use a drill and drill bit to clear the AQUAvalve5 nozzle. This will potentially damage the AQUAvalve5 beyond repair.
- 3** Always flush pipework thoroughly at the end of the growing season to remove any sediment.



Set Up Tips

- 1** Always ensure the surface you're placing your tray on is flat and sound, ideally with reference to a bar spirit level. Avoid setting up on surfaces such as gravel as these aggregates can shift over time.
- 2** If using a grow bag, fluff it up to loosen the media and perforate the underside before placing in the tray to improve aeration and drainage.
- 3** If growing outdoors remove the Overflow Plug, allowing any excess water that may accumulate during rainfall to escape. If heavy rainfall occurs turn your reservoir off until rain has stopped and the water has been drained / consumed. If growing indoors leave the Overflow Plug in place.
- 4** If using Tray2Grow with pots, trays, or planters always pre-soak the capillary matting and root control sheet before fitting.



In-Use Tips

- 1** Once your bag, planter, pots, or trays are in place and planted up water them through with a watering can. Allow your plants to take up this water before switching the system on.
- 2** As grow bags typically include some degree of feed within the grow media it's often best to supply plain water for a few weeks before gradually introducing liquid feeds via the reservoir and pipework.
- 3** In early stages irrigate judiciously. Consider switching Tray2Grow on and off intermittently in order for plants to establish.
- 4** If using pots or seed trays always ensure that they have holes on the underside that allow your grow media to be in contact with the root control sheet and matting beneath. This is essential in order for uptake of water and/or nutrients to occur

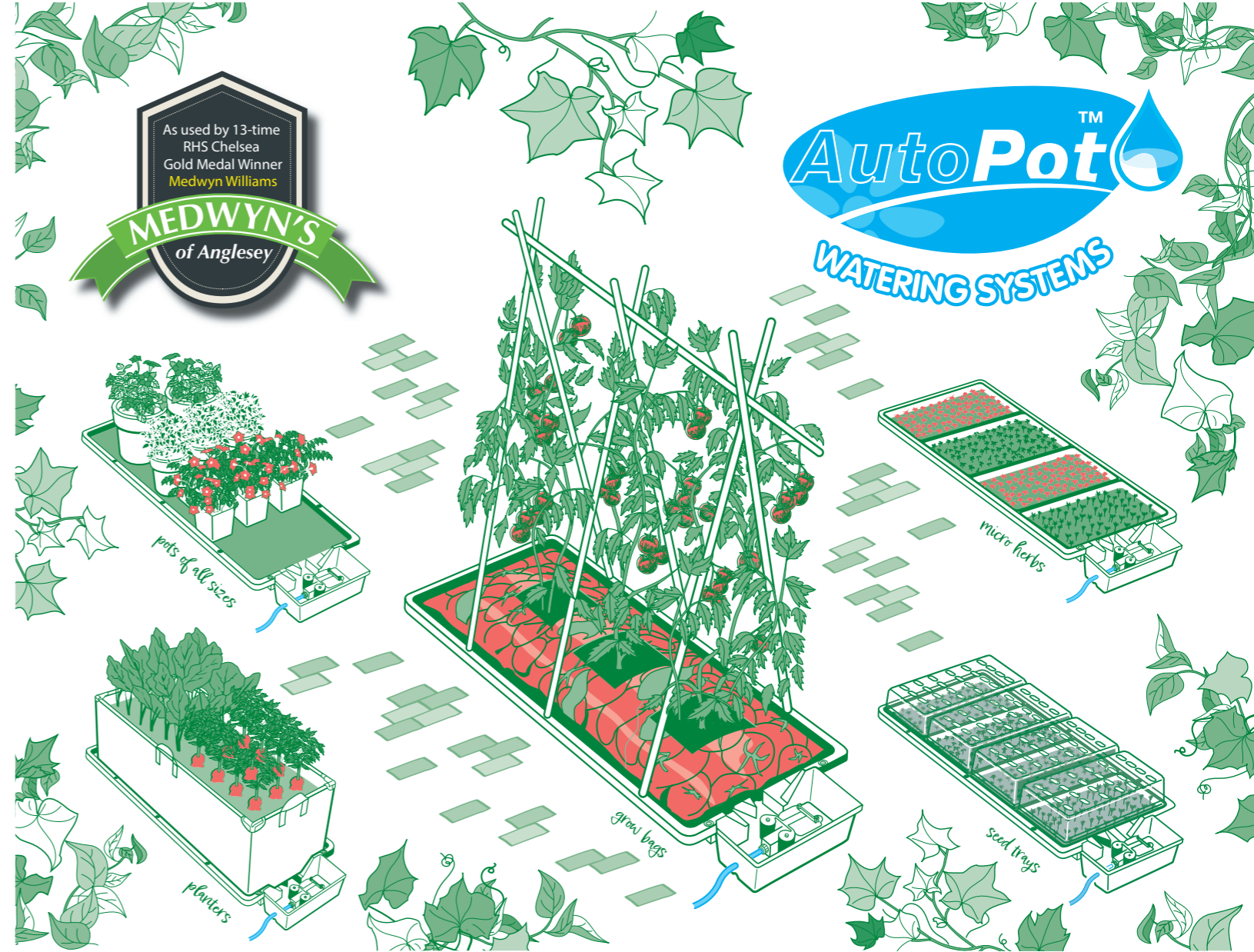

Set-Up Guide

Contents

- | | |
|---------------------------------------|-------------------------------|
| 1x Tray2Grow Tray & Lid | 3x Circular Spirit Level |
| 1x AQUAvalve5 | 10x Capillary Spikes |
| 2x 9mm / 3/8" Grommet | 10x Capillary Strips |
| 1m / 3.3ft of 9mm / 3/8" Pipe | 1x Capillary Matting |
| 1x 16-9mm / 1/2-3/8" Click-Fit Filter | 1x Root Control Sheet |
| 1x 9mm / 3/8" Golf Filter | 4x Seed Trays |
| 1x 6mm 1/4" Overflow Plug | 1x Slug Repellent Copper Tape |

Useful Information

Scan For Set-Up Video



Scan For Product Details

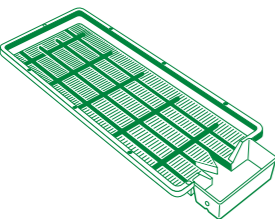

Initial Set-Up - All Methods

- 

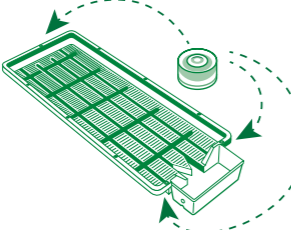
1 Position Tray2Grow on a level surface - use a bar spirit level to be sure. Avoid placing on gravel or similar aggregates.
- 

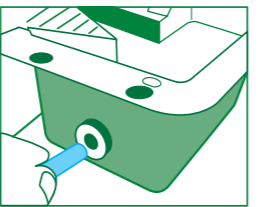
2 Insert and check spirit levels to ensure Tray2Grow is still sitting flat
- 

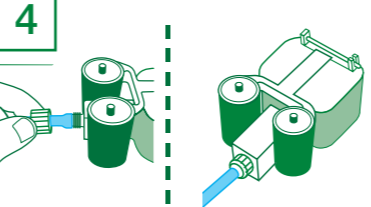
3 Thread 30cm / 12" of 9mm / 3/8" pipe into the tray through the open grommet in the tray wall. Wetting the pipe end with cold water helps harden it, aiding insertion.
- 

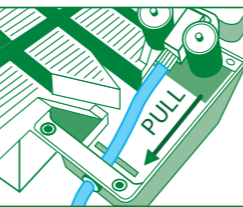
4 Attach pipe threaded into tray to AQUAvalve. Remove AQUAvalve collar. Push 9mm/3/8" pipe through collar and attach to nozzle. Rescrew collar. DON'T overturn...when you feel it grip STOP
- 

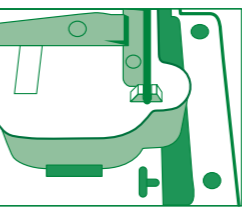
5 Remove any slack in the 9mm / 3/8" pipe by drawing excess out of the tray.
- 

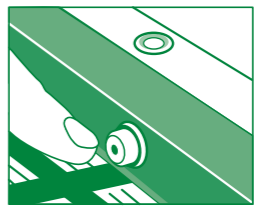
6 Align the 'half moon' section on the rear of the AQUAvalve with the 'T' section in the tray. Firmly push the AQUAvalve onto the 'T'.
- 

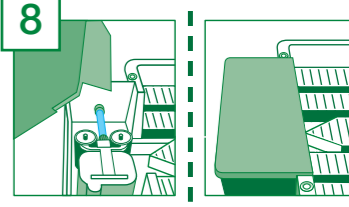
7 If growing outdoors remove the 6mm / 1/4" Overflow Plug from the front of the Tray2Grow. If growing indoors keep this plug in place.
- 

8 Place lid over the AQUAvalve compartment of the tray and press securely into position

Set-Up Guide A - Grow Bags

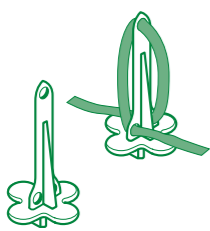
- 

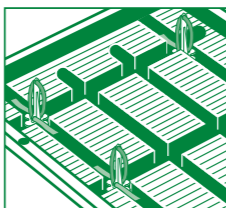
9a Loop capillary strips into grow bag spikes into grow bag spikes
- 

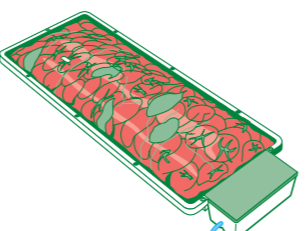
10a Push the grow bag spikes into the base of Tray2Grow
- 

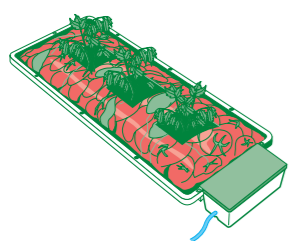
11a Fluff up your grow bag and perforate the underside multiple times at random. Place your grow bag into the Tray2Grow
- 

12a Plant up your grow bag and water through by hand
- 

13a Use canes in the cane support holes if training vine crops
- 

14a Apply slug-repellent copper tape all around the edge of the Tray2Grow

Set-Up Guide B - Trays, Pots & Planters

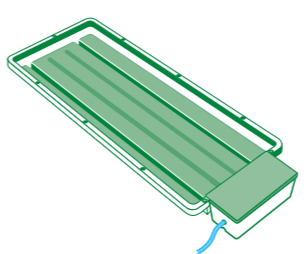
- 

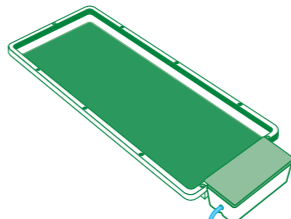
9b Wet and lay capillary matting into Tray2Grow, tuck into two outer channels **only**.
- 

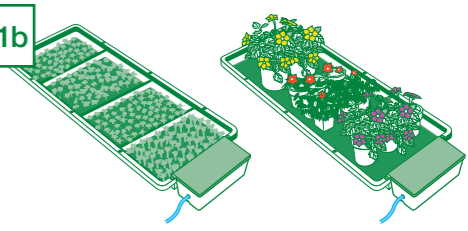
10b Wet and lay root control sheet on top of capillary matting. The root control sheet can be laid copper side up or down.
- 

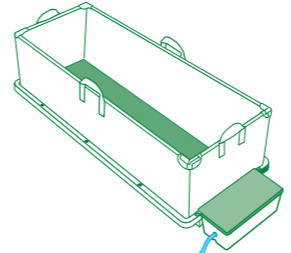
11b Place your planted-up seed trays or pots into Tray2Grow and water through. Pots and trays must have holes in the base that allow grow media to directly contact the root control sheet below.
- 

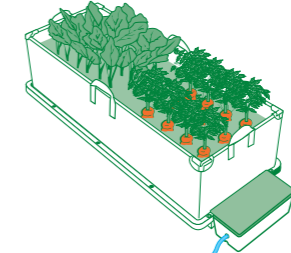
12b If using a planter position planter in the Tray2Grow first
- 

13b Then plant up the planter in Tray2Grow and water through
- 

14b Apply slug-repellent copper tape all around the edge of the Tray2Grow

Untapped Reservoir Connection

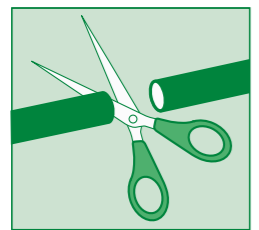
- 

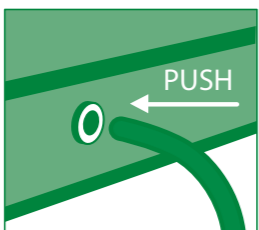
UR1 If necessary cut 9mm / 3/8" pipe to a length suitable for your setup.
- 

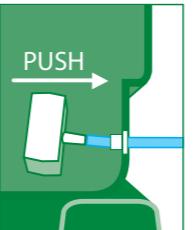
UR2 Use a step drill bit to drill a 12mm / 1/2" dia. hole in your reservoir. Push the 9mm / 3/8" grommet into your reservoir. Push 9mm / 3/8" pipe through grommet.
- 

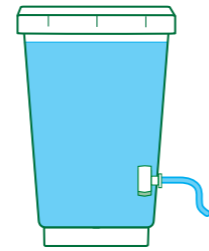
UR3 Inside the tank push the 9mm / 3/8" filter into 9mm / 3/8" pipe.
- 

UR4 10-14 days later fill your reservoir with water & fertiliser & switch on

Tapped Reservoir Connection

- 

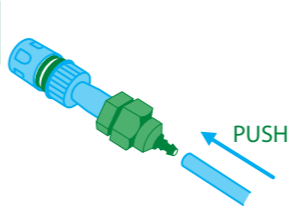
TR1 If necessary cut 9mm 3/8" pipe to a length suitable for your setup.
- 

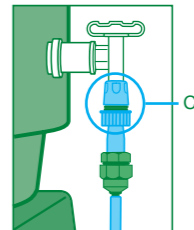
TR2 Connect 9mm / 3/8" pipe to the 16-9mm / 1/2-3/8" Click Fit Adapter and Filter
- 

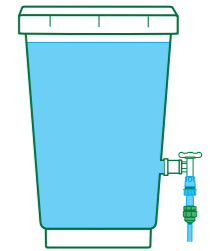
TR3 Connect 16-9mm / 1/2-3/8" Click Fit Filter to your reservoir tap. If your tap is not Click-Fit remove the collar from the Filter and push pipe directly onto tap.
- 

TR4 10-14 days later fill your reservoir with water & fertiliser & switch on